

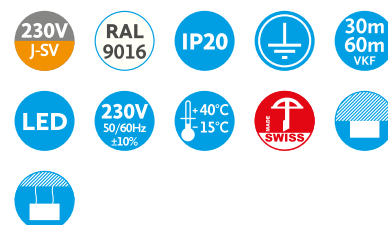

SNP DICE LED J-SV

Lampada di segnalazione vie di fuga per alimentazione da sistema 230V



DATI TECNICI

| | |
|--|---------------------------------|
| Numero articolo | CH750300 |
| Dimensione | 320x184(334)x320mm |
| Assorbimento DC | 32 mA |
| Sistema / Tecnologia | LED J-SV |
| Installazione | Soffitto, Montaggio con cordine |
| Materiale | Lamiera d'acciaio |
| Colore | Bianco traffico RAL9016 |
| Grado di protezione | IP 20 |
| Classe di isolamento | I |
| Distanza di visualizzazione EN1838 | 30 m / 60 m |
| Distanza di visualizzazione VKF (AICAA) | 30 m / 60 m |
| Fonte luminosa | LED |
| Corrente nominale AC | 230V ±10% 50/60Hz |
| Corrente nominale DC | 176 - 264 V |



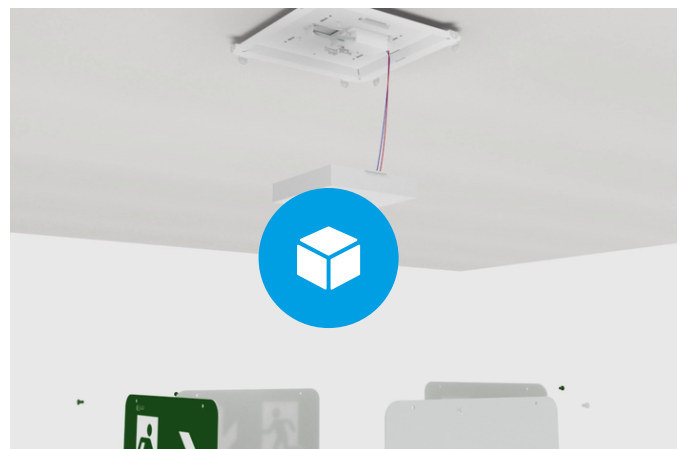
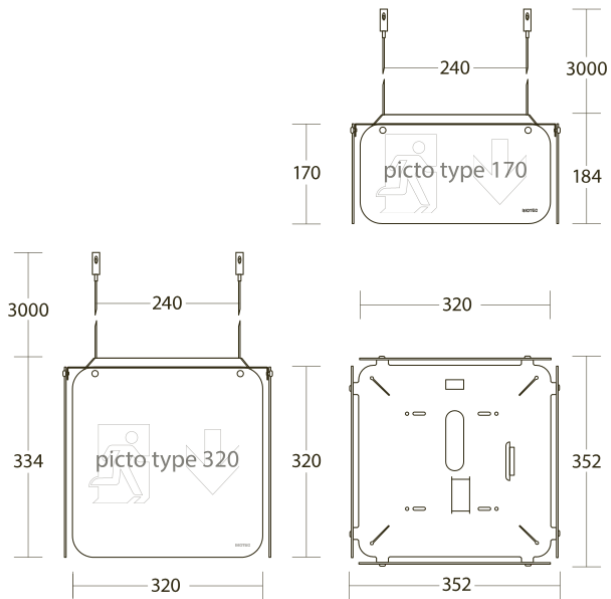

| | |
|----------------------------------|---|
| Gruppo di prodotto | Lampade di segnalazione di uscita di emergenza a quattro lati |
| Corrente di inserzione | Modulo 8A / 50µs |
| Morsetti di allacciamento | max. 2,5mm ² (Per cablaggio passante) |
| Temperatura di esercizio | -15°C...+40°C |
| Norme | SN-EN 60598-1, SN-EN 55015, SN-EN 60598-2-22, SN-EN 61547, SN-EN 1838, SN-EN 61000-3-2, SN-EN 62493, SN-EN 61000-3-3, SN-EN 62471 |
| Alimentazione | Elettronica d'alimentazione a 230V. Per connessione ai sistemi ad energia centralizzata con tecnica Joker e sorveglianza singola della lampada. Nel circuito questo apparecchio può funzionare in luce permanente (DL), luce non permanente (BL), luce dimmerata (DIM) oppure tramite comando d'accensione (quest'ultimo modo è possibile solo in funzionamento ordinario). 5 anni di garanzia sulle matrici LED. |
| Caratteristiche speciali | Prodotto Swiss Made (realizzato in Svizzera) |

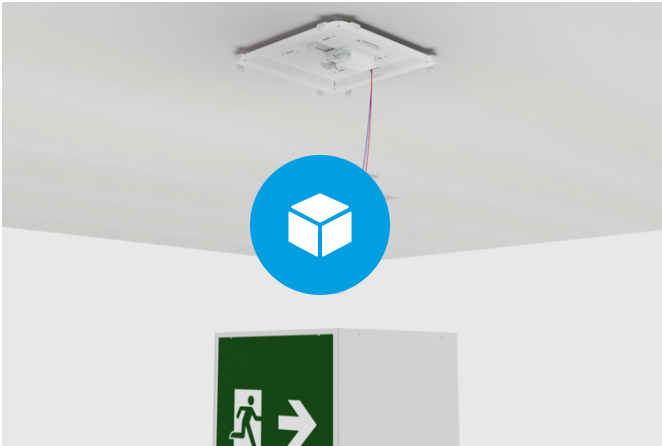
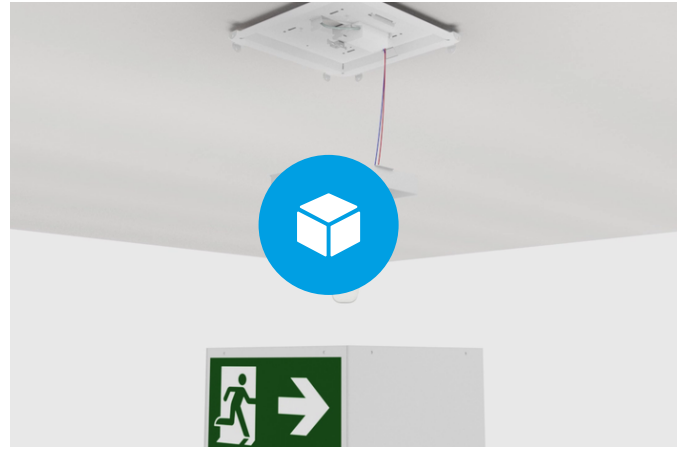
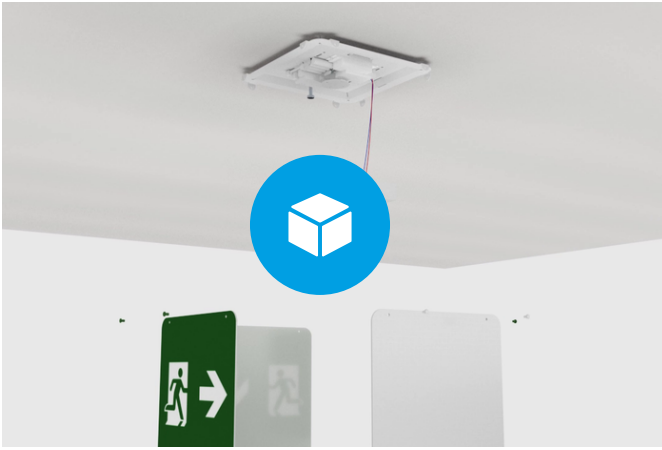







IMMAGINI















ACCESSORI

| Immagini | Numero articolo | Descrizione | Tipo di montaggio | Materiale | Colore |
|---|-----------------|---|-------------------|-----------|--------|
|  | CH750315 | Pittogramma DICE 320 PU (ML) ISO-7010 | | | |
|  | CH750318 | Pittogramma DICE 320 PO ISO-7010 | | | |
|  | CH750319 | Pittogramma DICE 320 PRO ISO-7010 | | | |
|  | CH750320 | Pittogramma DICE 320 PLO ISO-7010 | | | |

| Immagini | Numero articolo | Descrizione | Tipo di montaggio | Materiale | Colore |
|---|-----------------|---|-------------------|-----------|--------|
|  | CH750321 | Pittogramma DICE 320 PRU ISO-7010 | | | |
|  | CH750322 | Pittogramma DICE 320 PLU ISO-7010 | | | |
|  | CH750324 | Pittogramma DICE 170 PU (MR) ISO-7010 | | | |
|  | CH750328 | Pittogramma DICE 170 PO ISO-7010 | | | |
|  | CH750329 | Pittogramma DICE 170 PRO ISO-7010 | | | |
|  | CH750330 | Pittogramma DICE 170 PLO ISO-7010 | | | |
|  | CH750331 | Pittogramma DICE 170 PRU ISO-7010 | | | |
|  | CH750332 | Pittogramma DICE 170 PLU ISO-7010 | | | |
|  | CH750317 | Pittogramma DICE 320 PR ISO-7010 | | | |



| Immagini | Numero articolo | Descrizione | Tipo di montaggio | Materiale | Colore |
|---|-----------------|---|-------------------|-----------|--------|
|  | CH750316 | Pittogramma DICE 320 PL ISO-7010 | | | |
|  | CH750323 | Pittogramma DICE 320 BG cieco/verde | | | |
|  | CH750325 | Pittogramma DICE 170 PU (ML) ISO-7010 | | | |
|  | CH750326 | Pittogramma DICE 170 PL ISO-7010 | | | |
|  | CH750327 | Pittogramma DICE 170 PR ISO-7010 | | | |
|  | CH750333 | Pittogramma DICE 170 BG cieco/verde | | | |
|  | CH750345 | Set corda DICE | | | |
|  | CH750346 | Connettore pittogramma-set Dice 320/480 | | | |
|  | SA750190 | DICE Cube 347,5 x 347,5 x 347,5mm 5 lati chiusi | | | |
|  | SA750192 | DICE Cube 347,5 x 347,5 x 347,5mm 5 lati chiusi | | | |



APP.PRINT.PRODUCT.SIMILAR_PRODUCTS

| Immagini | Numero articolo | Descrizione | Tipo di montaggio | Materiale | Colore |
|---|-----------------|---------------------------------------|-------------------|-----------|--------|
|  | CH750305 | SNP DICE 480 LED J-SV | | | |

DOWNLOAD

PRODOTTO
 Scheda tecnica prodotti (PDF)

DATI BIM
 Dati BIM (file zip)

ISTRUZIONI
 Istruzioni di montaggio (PDF)

DICHIARAZIONE DI CONFORMITÀ
 Dichiarazione di conformità (PDF)

MONTAGGIO
 Istruzioni di montaggio (PDF)

CORESHOP.UI.PROD DOWNLOAD_TITLE.V

coreshop.ui.product_detail.dow

CORESHOP.UI.PROD DOWNLOAD_TITLE.V

coreshop.ui.product_detail.dow

CORESHOP.UI.PROD DOWNLOAD_TITLE.V

coreshop.ui.product_detail.dow

CORESHOP.UI.PROD DOWNLOAD_TITLE.V

coreshop.ui.product_detail.dow