



SNP DICE LED J-SV

Luminaire à pictogramme à alimentation par source centrale 230V

DONNÉES TECHNIQUES

Numéro d'article	CH750300	Courant d'enclenchement	Module 8A / 50µs
Dimension	320x184(334)x320mm	Section de raccordement	max. 2,5mm ² (Pour câblage traversant)
Courant nominal DC	32 mA	Température admissible	-15°C...+40°C
Système / Technologie	LED J-SV	Exécution	SN-EN 60598-1, SN-EN 55015, SN-EN 60598-2-22, SN-EN 61547, SN-EN 1838, SN-EN 61000-3-2, SN-EN 62493, SN-EN 61000-3-3, SN-EN 62471
Matériel	Tôle d'acier	Note importante	Module pour luminaire à courant constant destiné à l'alimentation de LED (tension du système 230V). Courant d'éclairage réglable en continu en mode réseau. Avec interrupteur d'adresse pour le codage des luminaires, fonction JOKER. Sélecteur de mode opératoire, lumière couplage permanent (DL), en couplage de veille (BL) ou lumière réglable (0-100%). 5 ans de garantie sur le LED.
Couleur	Blanc signalisation RAL9016	Caractéristiques spéciales	Produit Swiss Made (fabriqués en Suisse)
Type de protection	IP 20		
Classe de protection	I		
Distance de lisibilité EN1838	30 m / 60 m		
Distance de lisibilité VKF (AEAI)	30 m / 60 m		
Source d'éclairage	LED		
Courant nominal AC	230V ±10% 50/60Hz		
Courant nominal DC	176 - 264 V		
Groupe de produit			



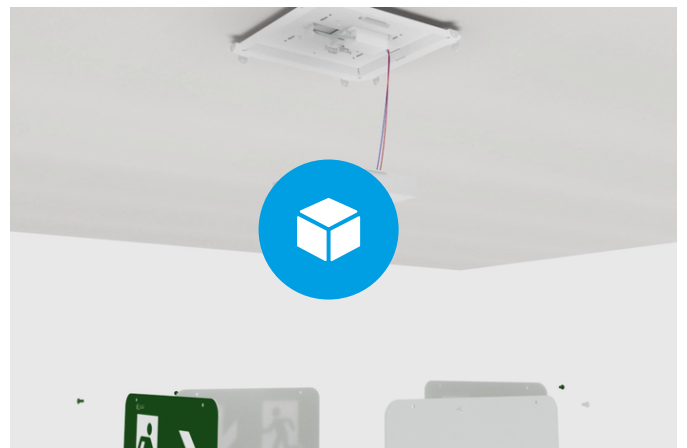
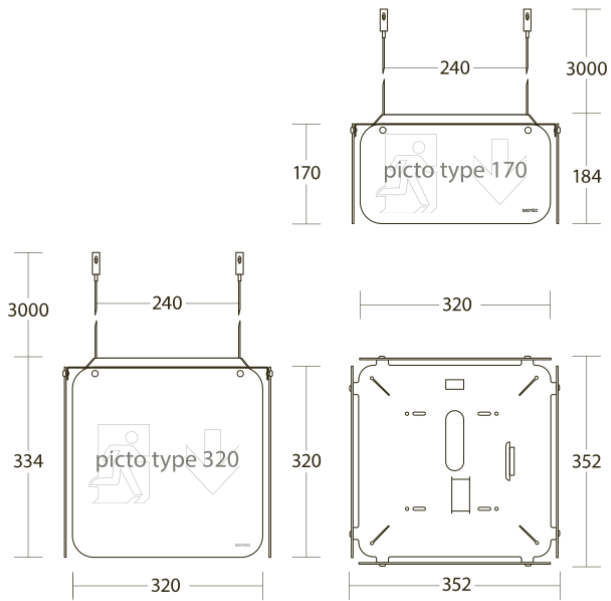

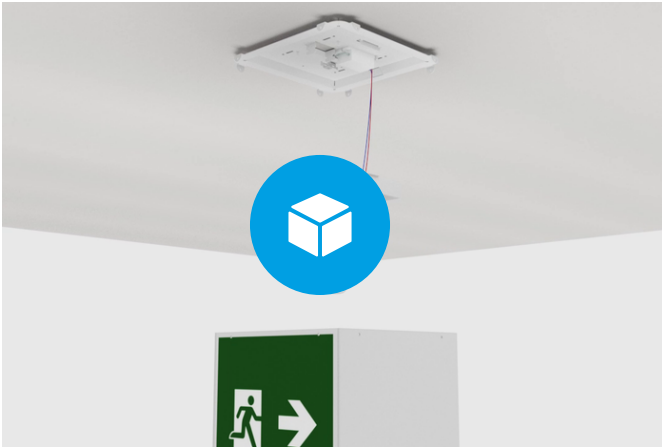
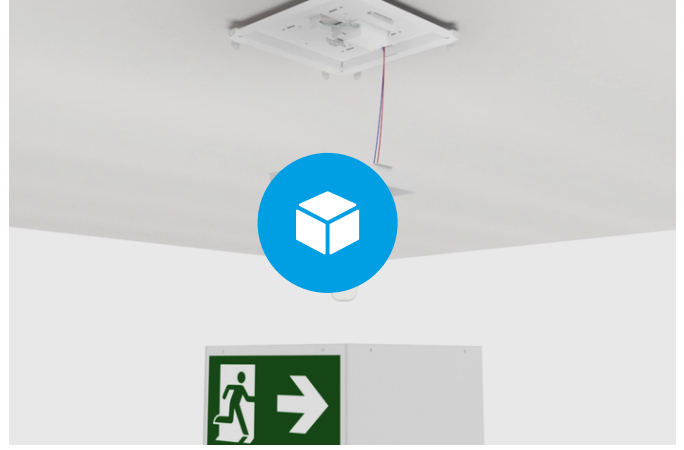
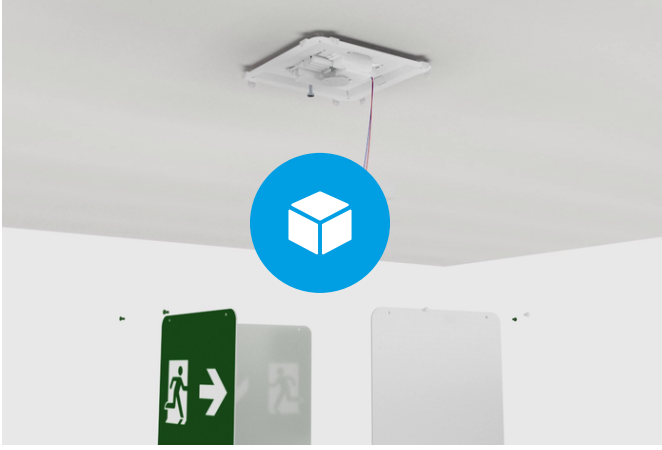



IMAGES















ACCESSOIRES

Images	Numéro d'article	Description	Type de montage	Matériau	Couleur
	CH750315	Pictogramme DICE 320 PU (ML) ISO-7010			
	CH750318	Pictogramme DICE 320 PO ISO-7010			
	CH750319	Pictogramme DICE 320 PRO ISO-7010			
	CH750320	Pictogramme DICE 320 PLO ISO-7010			

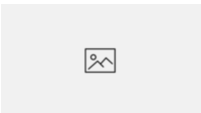
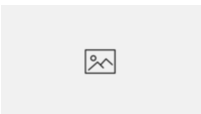
Images	Numéro d'article	Description	Type de montage	Matériau	Couleur
	CH750321	Pictogramme DICE 320 PRU ISO-7010			
	CH750322	Pictogramme DICE 320 PLU ISO-7010			
	CH750324	Pictogramme DICE 170 PU (MR) ISO-7010			
	CH750328	Pictogramme DICE 170 PO ISO-7010			
	CH750329	Pictogramme DICE 170 PRO ISO-7010			
	CH750330	Pictogramme DICE 170 PLO ISO-7010			
	CH750331	Pictogramme DICE 170 PRU ISO-7010			
	CH750332	Pictogramme DICE 170 PLU ISO-7010			
	CH750317	Pictogramme DICE 320 PR ISO-7010			

Images	Numéro d'article	Description	Type de montage	Matériau	Couleur
	CH750316	Pictogramme DICE 320 PL ISO-7010			
	CH750323	Pictogramme DICE 320 BG aveugle/vert			
	CH750325	Pictogramme DICE 170 PU (ML) ISO-7010			
	CH750326	Pictogramme DICE 170 PL ISO-7010			
	CH750327	Pictogramme DICE 170 PR ISO-7010			
	CH750333	Pictogramme DICE 170 BG aveugle/vert			
	CH750345	Kit de fixation à DICE			
	CH750346	Connecteur pictogramme-set Dice 320/480			
	SA750190	DICE Cube 347,5 x 347,5 x 347,5mm 5 faces fermées			
	SA750192	DICE Cube 347,5 x 347,5 x 347,5mm 5 faces fermées			

APP.PRINT.PRODUCT.SIMILAR_PRODUCTS

Images	Numéro d'article	Description	Type de montage	Matériau	Couleur
	CH750305	SNP DICE 480 LED J-SV			

TÉLÉCHARGEMENTS



PRODUIT
Afficher fiche technique (PDF)

[↓](#)



DONNÉES BIM
Données BIM (fichier zip)

[↓](#)



MODE D'EMPLOI
Instructions de montage (PDF)

[↓](#)



DÉCLARATION DE CONFORMITÉ
Déclaration de conformité (PDF)

[↓](#)



MONTAGE
Instructions de montage (PDF)

[↓](#)



CORESHOP.UI.PROD
DOWNLOAD_TITLE.V
coreshop.ui.product_detail.dow

[↓](#)



CORESHOP.UI.PROD
DOWNLOAD_TITLE.V
coreshop.ui.product_detail.dow

[↓](#)



CORESHOP.UI.PROD
DOWNLOAD_TITLE.V
coreshop.ui.product_detail.dow

[↓](#)



CORESHOP.UI.PROD
DOWNLOAD_TITLE.V
coreshop.ui.product_detail.dow

[↓](#)